

# ingenico

## AXIUM DX4000 Desktop

### User Guide



[www.ingenico.com](http://www.ingenico.com)

13-17 rue Pagès, 92150 Suresnes – France

Banks and Acquirers International Holding, SAS / 814 767 216 RCS Nanterre

# Contents

Table of Contents .....	2
1. Introduction .....	3
2. Presentation .....	4
2.1 Content of the box .....	4
2.2 Overview of AXIUM DX4000 Desktop .....	5
2.3 Key Locations and Functions .....	7
2.4 Touch Panel .....	7
3. Use of the terminal .....	8
3.1 Power on/Power off the terminal .....	8
3.2 Reading cards .....	9
3.3 Usage of Front Camera .....	10
3.4 USB Type-C .....	11
3.5 MAGIC BOX .....	11
4. Installation .....	15
4.1 Recommendations .....	15
4.2 Installing modules .....	16
4.3 Paper roll .....	19
4.4 Battery .....	21
4.5 Visual Impaired (VI) Accessory(optional) .....	23
5. Recommendations .....	24
5.1 Safety .....	24
5.2 Security of your terminal .....	26
5.3 Fixed installation .....	27
5.4 Cleaning the terminal .....	28
5.5 Transport and storage .....	29
6. Standards .....	30
7. Troubleshooting .....	35

# 1. Introduction

We hope that you will be fully satisfied with your new AXIUM DX4000 Desktop terminal.

Read this guide to understand and make the best use of your terminal. It presents you the necessary information about use, installation, maintenance, safety and security recommendations.



## **WARRANTY/SECURITY**

Use only the power supply included with the product to ensure best performance and safety. Maintenance should only be provided by Ingenico authorized technician. Failure to comply with these instructions will void the manufacturer's responsibility.



This symbol indicates an important Warning.



This symbol indicates a piece of advice.

## 2. Presentation

### 2.1 Contents of the box

- **AXIUM DX4000 Desktop terminal unit equipped with a paper roll**
- **Power adapter**
- **A battery pack**
- **This user guide**
- **One MAGIC BOX**



#### WARNING

The power supply unit provided with your equipment is specially designed for INGENICO AXIUM DX4000 Desktop terminal. Do not use any other power supply. The use of a power supply with apparently similar voltage/current characteristics may damage your terminal.



#### ADVICE

Keep the package. It must be re-used whenever the terminal is shipped.

In all EU member states, operation of 5150-5350MHz is restricted to indoor use only.



BE	BG	CZ	DK	DE	EE	IE	EL
ES	FR	HR	IT	CY	LV	LT	LU
HU	MT	NL	AT	PL	PT	RO	SI
SK	FI	SE	NO	IS	LI	CH	TR

## 2.2 Overview of AXIUM DX4000 Desktop

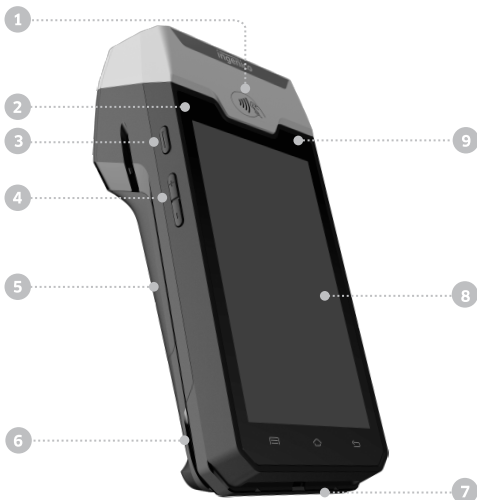

1) Contactless landing zone	2) LEDs for Contactless Card
3) Power key	4) Volume keys
5) Battery cover	6) Magnetic card reader
7) Smart Card reader	8) LCD and touch screen
9) Front Camera	

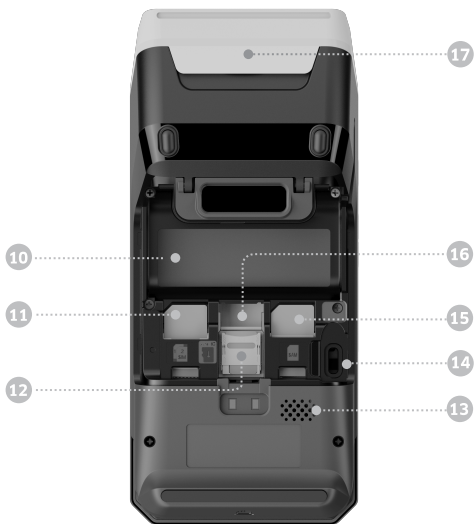

10) Battery compartment	11) SAM 2 card slot,SAM 1 card slot
12) Micro SD slot	13) Speaker
14) USB Type-C connector	15) SAM card slot
16) Battery socket	17) Easy Loading Printer

**Weight**

435g (including battery)

**Dimension (L x W x H)**

177.6 X 80 X 56.8mm

**Electrical mains network**

100-240VAC/50-60Hz Class II

## 2.3 Key Locations and Functions

Three physical keys on the left side of the terminal: a power button and two volume keys.

Three capacitive keys at the bottom of the screen: Menu, Home and Back keys.

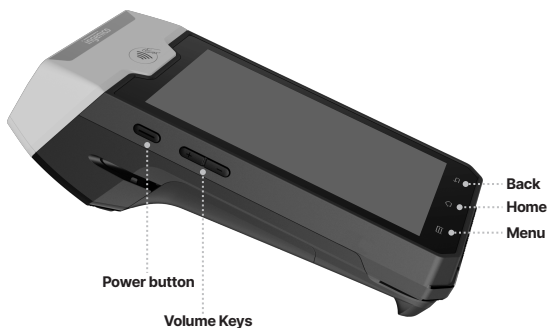

## 2.4 Touch Panel

The AXIUM DX4000 Desktop is equipped with touch panel that allows you capture functions and menus by your finger.

## 3. Use of the terminal



### ADVICE

Before using the terminal, always check if the roll of paper is present.

### 3.1 Power on/Power off the terminal

#### Power On Terminal:

- Make sure the terminal battery is correctly installed.
- Press <Power> button for about 1s until the display is turned on.

#### Power Off Terminal:

- Press and hold <Power> button for more than 2s until the display shows the following menu.
- Press <Power off>.

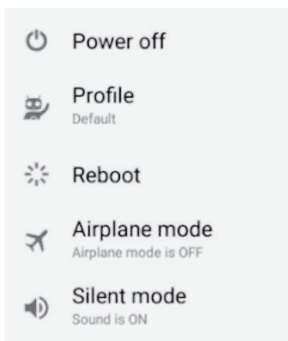

#### Battery Low:

- If the battery is empty, the terminal will automatically shut off.

#### Terminal restart:

- In the event of abnormal behavior of the terminal, press and hold the power button for 8 seconds to force the terminal to power off.



### Screen saver mode:

- To conserve battery power, the screen may be turned off with a short press of the power button. (approximately 0.5 seconds)

## 3.2 Reading cards

### Magnetic stripe card

- The card can be read bi-directionally, with the stripe facing the terminal.
- Use a regular movement in order to ensure a reliable card reading.

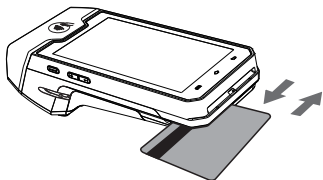

### Contactless card

- Bring the card firmly up to the active zone.
- Keep the card close to the reader during the transaction.
- On the front, LEDs are displayed to indicate transaction processing.

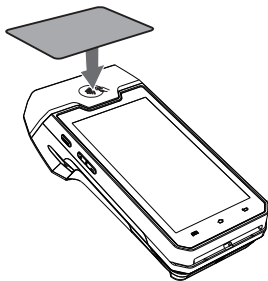

### Smart card

- Insert the card horizontally with the metal chip facing upward and leave in position throughout the transaction.

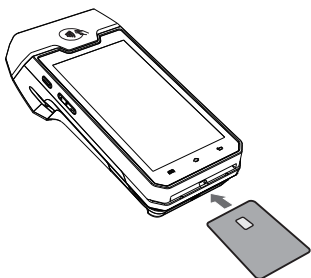

## 3.3 Usage of Front Camera

- The brightness of the mobile phone must be set to the brightest or not less than the 2/3 of the maximum brightness.
- The screen of the mobile phone must face the front scanning head above the terminal screen and keep it stationary.

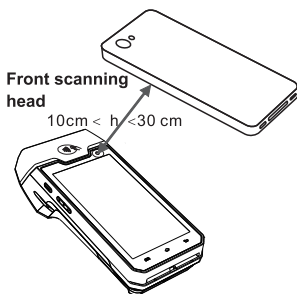

- The screen of the mobile phone must be parallel to the front scanning head.
- The vertical distance between the screen of the mobile phone and the front scanning head should be between 10~ 30 cm; 20 cm would be the best.
- The terminal will beep with a successful scanning.

## 3.4 USB Type-C

- There is a USB type-C connector on the bottom side of the terminal.
- The connector manages Host and Slave connections.

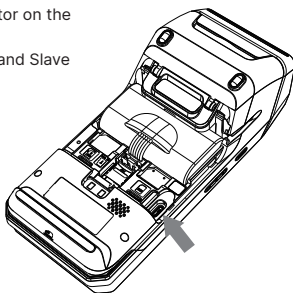

## 3.5 MAGIC BOX

### 3.5.1 Device Introduction

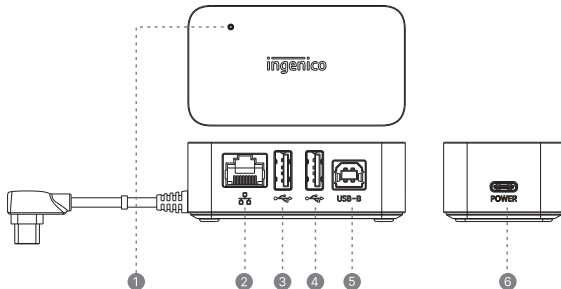

1. Power indicate led	2. RJ45 Network Interface
3. USB-TYPE A	4. USB-TYPE A(optional)
5. USB-TYPE B	6. USB-TYPE C Power Interface

## 3.5.2 Interface definition

### 1) RJ45 interface

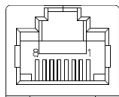

Sequence	RJ45 Signal
1	ETH_TX+
2	ETH_TX-
3	ETH_RX+
4	NC
5	NC
6	ETH_RX-
7	NC
8	NC

### 2) USB-TYPE A interface



Sequence	USB-TYPE A Signal
1	VBUS 5.0V
2	D-
3	D+
4	GND

### 3) USB-TYPE B interface

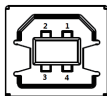

Sequence	USB-TYPE B Signal
1	Not connect
2	D-
3	D+
4	GND

### 4) USB-TYPE C interface

## 3.5.3 Product Technology Features

### Product Technology Specifications

Port	<ul style="list-style-type: none"> <li>a USB TYPE-C power input port</li> <li>a RJ45 network port</li> <li>a USB TYPE-A HOST port supporting USB2.0</li> <li>a USB TYPE-B DEVICE port supporting USB2.0</li> <li>a USB TYPE-C port supporting USB2.0</li> </ul>
Power	<ul style="list-style-type: none"> <li>Power input: 5.0V DC 2.0A/3.0A</li> <li>USB TYPE-A HOST output : 5.0V DC 0.5A</li> <li>USB TYPE-C output: 5V/1.8A(Power input with 5.0V/3.0A);</li> <li>5V/1.8A(Power input with 5.0V/2.0A,not use USB TYPE-A);</li> <li>5V/1.3A(Power input with 5.0V/2.0A, use one USB TYPE-A);</li> <li>5V/0.8A(Power input with 5.0V/2.0A, use two USB TYPE-A);</li> </ul>
Size and Weight	<ul style="list-style-type: none"> <li>Size: 74mmx41mmx26mm</li> <li>Net Weight: 100g</li> <li>Gross Weight: 124g</li> </ul>

## Environmental conditions

Environmental conditions for running, storing and delivering the product:

Temperature	Running	0°C ~ 40°C/ 32°F ~ 104°F
	Storage and Delivery	-20°C ~ 70°C/ -4°F ~ 158°F
Humidity	Running	10% ~ 90%
	Storage and Delivery	5% ~ 90% (40°C) / (104°F)
Atmospheric pressure		86kPa ~ 106 k Pa; Below 2000 meters above sea level

## Product Functions

The MAGIC BOX has two main functions as below:

- DX4000 charging: Connect the MAGIC BOX with the power adapter, then connect DX4000 with the MAGIC BOX to get charged.
- Serves as extended communication ports of DX4000: Network port, USB port.

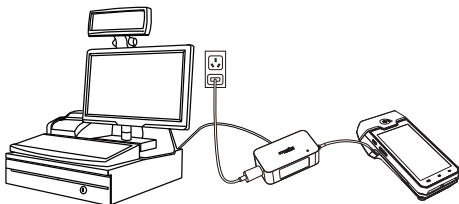

## 3.5.4 Installation

Connect MAGIC BOX with DX4000

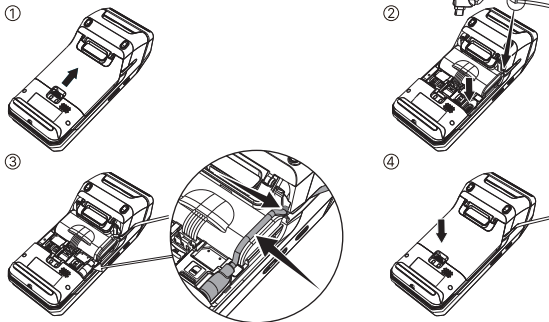

**Note:** Please put the cable to the correct position in the battery compartment, as the third picture shown

## Fixing of MAGIC BOX(optional)

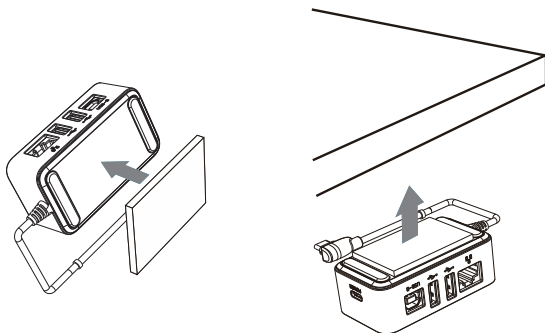

### 3.5.5 Notes

#### Notes

- Prevent the terminal from sun exposure, high temperature, moisture and other mean conditions.
- Cut off the power before cleaning the device and wipe the main body with dry cloth.
- When the following abnormal phenomena occur, stop running the device immediately, cut off the power supply, and report to the service provider as soon as possible:
  - 1) harsh noise heard during operation.
  - 2) impurities or water found in the machine.
  - 3) Unpleasant smell found during operation.

### 3.5.6 Delivery and Storage

#### Delivery and Storage

- Avoid rain and snow, sun exposure and mechanical impact.
- The product should be stored in the original box. The box should be at least 15cm away from the floor, at least 50cm from the wall, heat source, cold source, window or air inlet.

## 4. Installation

### 4.1 Recommendations

#### Operating conditions

Ambient temperature*	From -10°C to +50°C (14°F to 122°F)
Max relative humidity	From 10% to 90%, Non-condensing

(\*)Excluding battery charging

#### Battery charging conditions

Ambient temperature	From 0°C to +40°C (32°F to 104°F)
---------------------	-----------------------------------

#### Storage conditions

Ambient temperature	From -20°C to +70°C (-4°F to 158°F)
Max relative humidity	From 5% to 90%, Non-condensing

## 4.2 Installing modules

### 4.2.1 SAM



#### **WARNING**

Switch off the terminal before opening the battery door.

The SAM connectors are located inside the terminal, in a closed compartment.

- Turn the terminal and remove the battery door.

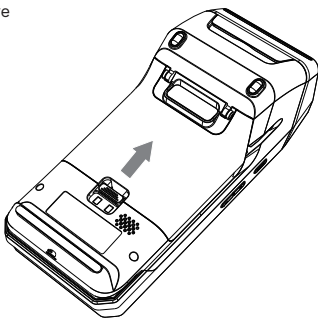

- SAMs are identified by the engraved marks on the lower housing.



- When introducing a SAM into slot, be sure to put the cut corner as indicated on the picture.
- Close the battery door.

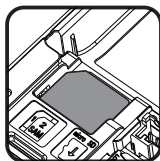
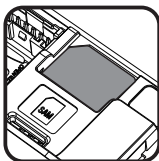
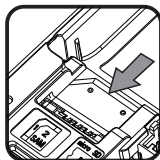
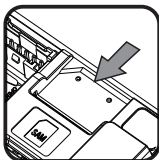

### ADVICE

AXIUM DX4000 Desktop is equipped with a dual SAM slot. When using two SAM cards, it is recommended to insert the bottom one first, then the top one.

When using only one SAM card, it is recommended to insert SAM1 slot (bottom).

## 4.2.2 MicroSD Memory Card



### WARNING

Switch off the terminal before opening the battery door.

MicroSD connector is located inside the terminal, in a closed compartment.

- Turn the terminal and remove the battery door.
- MicroSD are identified by the engraved marks on the lower housing.
- Slide the cover to the end and pull to open it. Insert MicroSD card, push the cover to close and slide it to the top to lock it. Be sure to put the MicroSD card contacts downside and the cut corner as indicated on the figure.
- Close the battery door.

The terminal supports MicroSD up to 32GB.

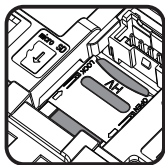
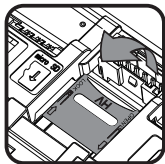

## 4.3 Paper roll

### 4.3.1 Main characteristics of INGENICO paper roll

R40 paper roll characteristics	Precisions
Color	White
Width	58mm
Diameter	40mm
Length	About 18 meters

- The thermal paper can be deteriorated by poor storage conditions,so we recommend you to avoid:
  - Storage in hot wet places(near air-conditioner,humidity higher than 85%).
  - Exposure to sunlight or ultraviolet for long periods.
  - Contact with organic solvents(solvent type adhesive).
  - Direct contact with materials containing plasticizers (PVC transparent folders or envelopes).
  - Direct contact with <<diazo>>papers.
  - Direct contact with water.
  - Rubbing or pressing the paper too strongly.



#### WARNING

For best product performance, only use heat sensitized paper approved by Ingenico.

### 4.3.2 Installing paper roll

- Open the paper cover by lifting the catch located at the top of AXIUM DX4000 Desktop and pull the cover to the rear of the terminal.
- Insert the paper roll in the compartment following the directions shown on the below picture.
- Pull the paper up to the top of terminal, maintain the paper and close the cover.
- Press simultaneously on both upper corners of the paper flap until it clips into position.
- Please note that the paper should be cut off upward.

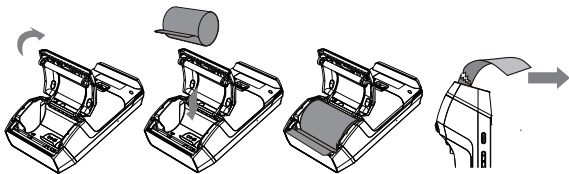

#### ADVICE

If you insert a new R40 paper roll, tear off the first length (one complete turn to avoid printing on adhesive footprint).



#### WARNING

Switch off the terminal prior to installing a paper roll. Use only paper approved by Ingenico.

The use of no-approved paper is likely to damage the printer of your terminal.

## 4.4 Battery

### 4.4.1 Charging the battery

- When does the battery need to be charged?
  - For safety reasons, the battery included with the terminal is not fully charged. Please charge the battery before use.
  - When used daily, the terminal charges its battery each time the power adapter is connected. Charging starts automatically.
- How can the battery be charged?

Using the power adapter

  - Connect the power adapter to the terminal USB type-C connector located on the left side of the terminal.
  - Connect the power adapter to the power supply mains network.
  - Check the charging status on the top of the screen(it means battery charging).

### 4.4.2 Installing the battery



#### **WARNING**

Check that the terminal is not connected to the main electric network.

- Turn your terminal and unclip the battery door by pushing the clips as shown with the arrow on the picture.
- Disengage the battery door.
- Take the battery pack included in the box.
- Locate the battery pack connector beside the battery compartment.
- Plug the battery pack connector according to the connector locating system.

- Place the battery pack in its compartment.
- Close the battery door.

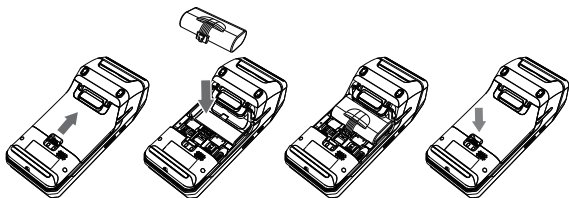

#### 4.4.3 Remove the battery

- Disengage the battery door.
- Remove the battery pack from the battery compartment.
- Unplug the battery pack connector.
- Close the battery door.

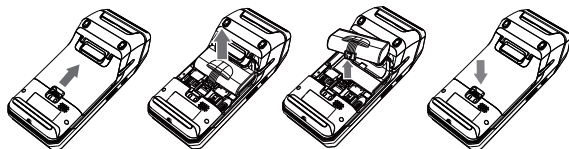

## 4.5 Visual Impaired (VI) Accessory(optional)

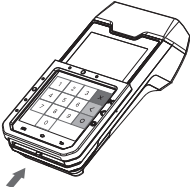
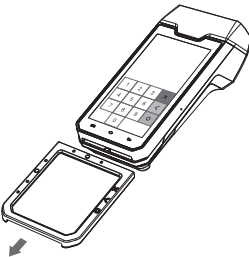
<p><b>Install</b></p> <ul style="list-style-type: none"><li>● slide the accessory onto the terminal from the bottom.</li></ul>	<p><b>Remove</b></p> <ul style="list-style-type: none"><li>● slide the accessory down and away from the terminal</li></ul>
	

# 5 Recommendations

## 5.1 Safety

### Powering down the AXIUM DX4000 Desktop

Disconnect the AXIUM DX4000 Desktop power supply block adapter from the electrical mains network.

### Lithium cell

The AXIUM DX4000 Desktop is fitted with an internal lithium cell which should only be accessed by a qualified technician.

### Battery

- AXIUM DX4000 Desktop is fitted with battery specially designed for this terminal.
- Only use the appropriate chargers and batteries listed in the ingenico's catalogue.
- Do not short-circuit the battery.
- Do not attempt to open the battery container.
- Used batteries must be disposed of at the appropriated sites.

The lifespan of battery depends on:

- Features used.
- Number of charge and discharge cycles.
- Use temperature.



### CAUTION

RISK OF EXPLOSION BATTERY IS REPLACED BY AN INCORRECT TYPE.  
DISPOSE OF USED BATTERIES ACCORDING TO THE INSTRUCTIONS.



### **SAM Readers compartment**

- The battery door for battery, SAM readers located underneath the terminal, must be in place during the normal operation of the terminal.
- See sections “Installing modules” and “Installing the battery”.

### **On airplanes**

- Your terminal must be switched off by removing the battery pack. Remove the battery from the terminal when on an airplane.
- Non-compliance with these safety rules may result in legal action and/or a ban on later access to cellular network services.

### **Explosion areas**

- Some regulations restrict the use of radio equipment in chemical plants, fuel depots and any site where blasting is carried out.
- You are urged to comply with these regulations.
- The terminal shall be protected by a specially fitted and certified cover enabling use in proximity to a fuel pump.

### **Thunderstorm weather**

- According to some relevant reports, the mobile phone electromagnetic wave is good conductor of lightning.
- It is much easier to suffer lightning strike when the damp atmosphere form a magnetic conductivity, especially in open areas.
- Do not use wireless terminals under thunderstorm weather.

### **Electronic health appliances**

- Your terminal is a radio transmitter which may interfere with health appliances, such as hearing aids, pacemaker, hospital equipment, etc.
- Your doctor or the equipment manufacturer will be able to provide you with appropriate advice.

## 5.2 Security of your terminal

Your device fulfills current applicable PCI PTS security requirements.

Upon receipt of your terminal you should check for signs of tampering of the equipment. It is strongly advised that these checks are performed regularly after receipt. You should check, for example: that the keypad is firmly in place; that there is no evidence of unusual wires that have been connected to any ports on your terminal or associated equipment, the chip card reader, or any other part of your terminal. Such checks would provide warning of any unauthorized modifications to your terminal, and other suspicious behavior of individuals that have access to your terminal. Your terminal detects any “tampered state”. In this state the terminal will repeatedly flash the message “Warning Detected” and further use of the terminal will not be possible. If you observe the “Warning Detected” message, you should contact the terminal helpdesk immediately.

You are strongly advised to ensure that privileged access to your terminal is only granted to staff that have been independently verified as being trustworthy. The terminal must never be put in or left at a location where it could be stolen or replaced by another device.

## 5.3 Fixed installation

If the device is to be used in a situation where it is not possible for the cardholder to pick up and shield their PIN entry themselves, the device may be used, but it must be installed in the following manner:

- The device must be angled at 45 or more, so that oversight of the PIN entry from the rear of the device is not possible.
- The device must either be fitted in a swivel stand - so that the customer can position the device in the best angle to prevent oversight - or the device must be fixed in the best possible position to prevent oversight if such a generic position exists in the specific environment to which the device is installed.
- The device environment must be accompanied with conspicuous notices and educational material which informs the customer to shield their PIN during PIN entry.
- The device must be deployed so that oversight from other customers, either in different payment lanes, or in other areas of the shopping environment, is prevented. This may be achieved through the placement of the lanes and device, so that the customer is automatically positioned between the device keypad and other customers. Alternatively, it may be achieved by the environment in which the device is installed, so that the checkout itself shields the PIN entry process.
- The terminal is exclusively made for indoor use.



## ADVICE

Positioning of the terminal on check stand must be in such a way to make cardholder PIN (Personal Identification Number) spying infeasible.

Installing device on an adjustable stand must be in such a way that consumers can swivel the terminal sideways and/or tilt it forwards/backwards to a position that makes visual observation of the PIN-entry process difficult.

Positioning of in-store security cameras such that the PIN-entry keypad is not visible.

**NEVER** ask the customer to divulge their PIN Code. Customers should be advised to ensure that they are not being overlooked when entering their PIN Code.

## 5.4 Cleaning the terminal

Good rules for proper cleaning of the terminal are:

- Unplug all wires from the terminal prior to cleaning.
- Apply soapy water or other approved cleaning product to a soft, non-abrasive cloth.
- **CLEANING PRODUCT SHOULD BE APPLIED TO THE CLEANING CLOTH AND NOT DIRECTLY APPLIED OR SPRAYED TO THE TERMINAL.** Failure to follow this step may result in damage to the terminal.
- Do not clean the electrical connections.
- Do not use solvents, detergents or abrasive products: Those materials might damage the plastic or electrical contacts.
- Avoid prolonged exposure of the terminal to the direct rays of the sun.
- Do not put anything other than credit cards into the slot of the smart card reader.

## 5.5 Transport and storage

When transporting the terminal

- Protect the terminal from snow, rain, and excessive exposure to the sun.
- Transport with care to avoid mechanical impact.
- Do not throw the unit forcibly. Prevent the package from intrusion during transportation to avoid breakage. The product should be stored in the original packaging.
- Do not store in warehouses that also contain harmful gases, or inflammable, explosive, or corrosive chemicals.
- Do not expose to strong mechanical vibrations or strong magnetic fields.
- Packaging should be stored at least 15 cm above the ground and be kept away from heat, cold, windows, or air inlet sources by at least 50cm.
- Follow the specific stored conditions as noted in Section 4 of this document.

## 6. Standards

### CE MARKING

The CE marking indicates AXIUM DX4000 Desktop complies with the requirements of European Directive 2014/53/EU on Radio Equipment for:

- The protection of the health and the safety of the user and any other person.
- The protection requirements with respect to electromagnetic compatibility.

And complies with harmonized standards, as well as RoHS Directive 2011/65/EU and its amendment directives.

### Operating Frequency Band (RF)

2.4GHz Wi-Fi:2412-2472MHz(TX/RX)

BT/BLE:2402-2480MHz(TX/RX)

NFC:13.56MHz(TX/RX)

5.2 GHz Wi-Fi:5150-5250 MHz(TX/RX), 5.3 GHz Wi-Fi:5250-5350(TX/RX),

5.6 GHz Wi-Fi:5470-5725 MHz(TX/RX), 5.8 GHz Wi-Fi:5725-5850(TX/RX)

### Max Of Transmit Power

BT:9.06dBm

BLE:3.85dBm

2.4GHz Wi-Fi: 18.53 dBm

5.2GHz Wi-Fi: 16.64dBm,5.3GHz Wi-Fi: 17.01dBm,5.6GHz Wi-Fi: 16.13dBm,

5.8GHz Wi-Fi: 13.82dBm

NFC:9.48dBuA/m@3m

### Environment (WEEE, Batteries and packaging)

This product is labeled in accordance with European Directives 2012/19/EU concerning Waste Electrical and Electronic Equipment (WEEE) and 2013/56/EU concerning Batteries and Accumulators. Those provisions are requiring producers and manufacturers to become liable for take-back, treatment and recycling upon end of life of equipment and batteries.

### BATTERIES

If your product contains batteries,they must be disposed of at appropriate collection points.

## THE PRODUCT



The crossed-out waste bin stuck on the product or its accessories means that the product belongs to the family of electrical and electronic equipment, and waste batteries must not be thrown away but collected separately and recycled.

Please contact your retailers for more detailed information about the compliance solution in place for disposing of your old product and used batteries.

Packaging waste must also be collected separately to assure a proper disposal and recycling.

In this way you can participate in the re-use and upgrading of Electrical and Electronic Equipment Waste, which can have an effect on the environment and human health.

## Electrical power supply network

The electrical outlet must meet the following criteria:

- Must be installed near the equipment and easily accessible.
- Do not short-circuit the battery.
- Do not attempt to open the battery container.



The power supply label contains eighteen symbols:



CCC (China Compulsory Certificate) Mark



The Regulatory Compliance Mark (RCM)



International Efficiency Marking Protocol (Energy Star Level 6)



In door use only



“Conformite Europe enne” or CE Mark



Double insulation symbol



5 Years China RoHS symbol



10 Years China RoHS symbol



BSMI (Taiwan)



PSE Mark (Japan)



Recycle in accordance with the waste electronic & electrical equipment directive



Underwriters Laboratories Inc (US Compliance)



Made from recyclable material



Low density version of Polyethylene (LDPE)



Chlorinated Polyethylene ( CPE)



Risk of explosion if the battery is incorrectly replaced or is placed in a fire



Dispose of batteries at a hazardous waste collection site or recycling facility



Direct Current

## 7. Troubleshooting

**Q:** The terminal cannot be started.

**A:** The device may be in a low energy status or an application running on the device may be in a defective state. Please ensure that the device is powered, and then reset the device. If this still fails, please contact our customer service department for help.

**Q:** Printer cannot work.

**A:** This may be caused by abnormal power supply or incorrect paper installation.

Check the battery status or the terminal power connection. If the remaining battery power is insufficient for a complete printing operation, the printer will not print the paper.

Check the printer roller and if the paper dust cover is correctly installed.

If the problem still exists, please contact our customer service center.

**Q:** Transaction Processing Failure.

**A:** Following reasons are likely to cause transaction failure: damaged magnetic card or smart card SAM card, damaged card reader, improper operation of card swiping, damaged or unconnected, unconnected phone line, etc.

- Try to use more than one magnetic card to test the transaction, to confirm the failure is not caused by magnetic card.
- Make sure card swiping is operated correctly.
- Manually process the transaction instead of card reader. If manual transaction works, the failure may be caused by magnetic card reader.
- Use more than one smart card to test the transaction, to confirm the failure is not caused by smart card. Make sure the SAM card is correctly inserted into the card slot.
- Check if the SIM card is installed correctly and local wireless communication network functions or not.

If there is still problem, please contact our customer service center.

“INGENICO is a trademark of BANKS AND ACQUIRERS INTERNATIONAL HOLDING . This Document is Copyright © 2023 BANKS AND ACQUIRERS INTERNATIONAL HOLDING . BANKS AND ACQUIRERS INTERNATIONAL HOLDING retains full copyright ownership, rights and protection in all material contained in this document. The recipient can receive this document on the condition that he will keep the document confidential and will not use its contents in any form or by any means, except as agreed beforehand, without the prior written permission of BANKS AND ACQUIRERS INTERNATIONAL HOLDING. Moreover, nobody is authorized to place this document at the disposal of any third party without the prior written permission of BANKS AND ACQUIRERS INTERNATIONAL HOLDING. If such permission is granted, it will be subject to the condition that the recipient ensures that any other recipient of this document, or information contained therein, is held responsible to BANKS AND ACQUIRERS INTERNATIONAL HOLDING for the confidentiality of that information. Care has been taken to ensure that the content of this document is as accurate as possible. BANKS AND ACQUIRERS INTERNATIONAL HOLDING however declines any responsibility for inaccurate, incomplete or outdated information. The contents of this document may change from time to time without prior notice, and do not create, specify, modify or replace any new or prior contractual obligations agreed upon in writing between BANKS AND ACQUIRERS INTERNATIONAL HOLDING and the user. BANKS AND ACQUIRERS INTERNATIONAL HOLDING is not responsible for any use of this device, which would be non-consistent with the present document. All trademarks used in this document remain the property of their rightful owners”

[www.ingenico.com](http://www.ingenico.com)

13-17 rue Pagès, 92150 Suresnes – France

Banks and Acquirers International Holding, SAS / 814 767 216 RCS Nanterre

